

SHARP

MX-C300F MX-C250F

Digital Full Colour Multifunctional System

Four-in-One Efficiency and
Advanced Features packed
in a Compact, Stylish A4
Colour MFP



MX-C300F

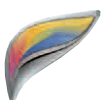

COPY

NETWORK PRINT

NETWORK SCAN

SHARPLESS

FAX

4-in-1 Function and Desktop Convenience

Put Document Efficiency in Easy Reach

Stylishly compact and designed for high performance, both MX-C300F and the MX-C250F are sized and equipped to suit any business setting or application. These handy A4 solutions—with footprint of just 429 x 509 mm—deliver full-colour performance and efficient four-in-one functionality right from a desk or countertop.



COPYING AND PRINTING

 : Copy  : Print

Efficient Colour and B/W Output

The MX-C300F/C250F delivers a fast output of **30/25 cpm/ppm*** in full colour and in B/W. And the first copy comes out in just **10 seconds** in B/W and **18 seconds** in full colour to save valuable time when performing multiple short-run jobs. A warm-up time of just **29 seconds** brings added efficiency.

* A4 (8 1/2" x 11"), short-edge feeding

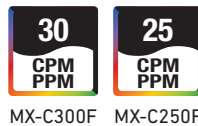

Superb Image Quality

Sharp's latest 3rd-generation **Mycrostoner-HG** (High Grade) and a dual-component developer system combine to provide breathtaking image quality. The toner's smaller particle size reduces graininess and enables clear reproduction of fine lines, fine text, and halftone colours.



Effective Paper Handling

The MX-C300F/C250F comes standard with a 250-sheet paper tray and a 50-sheet multi-bypass tray. A 500-sheet paper feed unit is optionally available for a total paper capacity of **800 sheets**. The MX-C300F/C250F can also accommodate heavy paper up to **220 g/m²**, expanding the range of possible printing applications.

Built-In Duplex Module

The MX-C300F's standard-equipped **50-sheet RSPF** (reversing single pass feeder) and the MX-C250F's **35-sheet SPF** (single pass feeder) ensure efficient document feeding. Both the MX-C300F and the MX-C250F can also make two-sided copies and printouts using a built-in stackless duplex module, effectively reducing paper costs.



MX-C300F

ID Card Copy

The MX-C300F/C250F has a dedicated key for easy copying of both sides of a card (ID cards, credit cards, etc.) onto a single page.

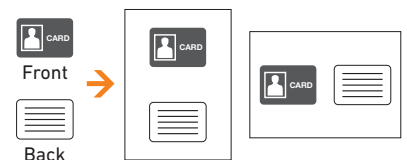

Direct Printing

The MX-C300F/C250F can print PDF, TIFF, and JPEG files without using the printer driver. And there's a USB port beneath the control panel, which comes in handy when printing data directly from USB memory devices—an indispensable function for users who are in a hurry or who want quick machine access without a PC.

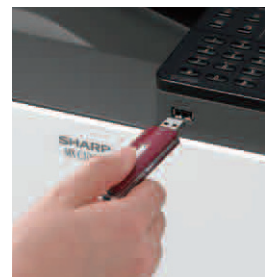

Network Printing

The MX-C300F/C250F works as a network printer with the latest and most commonly used operating systems and network protocols, including **IPv6**, and even in mixed OS environments. It also supports, as standard, the **PCL 6** and **PostScript 3** printer languages.

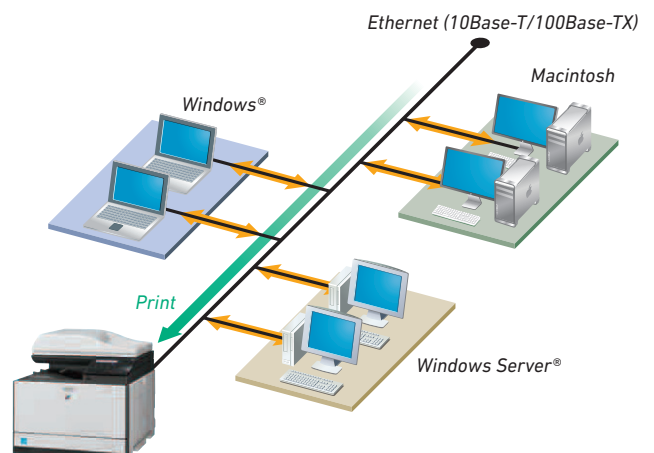

Full-Colour Network Scanning

The MX-C300F/C250F works as a full-colour network scanner and supports TIFF, PDF, and JPEG file formats. Converting any type of paper-based document into an editable digital file is as easy as making a copy.

Multiple Distribution of Scanned Files

You can choose different ways to distribute your scanned documents: for example, send as an e-mail attachment or scan directly to an FTP server for storage.

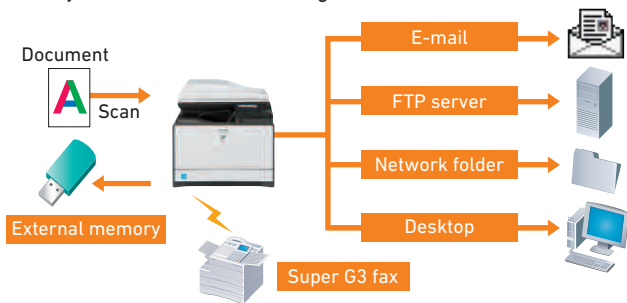

Business Card Scanning

MX-C300F

The MX-C300F can easily scan business cards* with its RSPF and can be used with commercially available business card scan software to create business card databases.

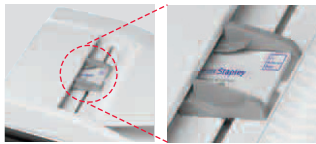

* One-sided scanning

LDAP Support

Built-in LDAP (lightweight directory access protocol) support eliminates the need to enter or register full addresses. Entering just the first few letters of a recipient's name prompts the MX-C300F/C250F to display a list of possible matches from your company's LDAP server. Selected addresses can be stored to the MX-C300F/C250F's address book.

Scanner Program Keys

Scanner Program Keys on the control panel enable users to register frequently used scan settings and destinations for easy, one-touch recall.

Sharpdesk

Sharpdesk is an original Sharp application that provides integrated desktop management of documents in over **200 file formats**, including scanned images and documents created with popular applications such as Word. With Sharpdesk, documents can be organised, edited, searched, and distributed with simple drag-and-drop operation. Features include **thumbnail** viewing, **annotation** tools for paper-free proofreading, optical character recognition, the ability to combine different types of files into a single document, and more.

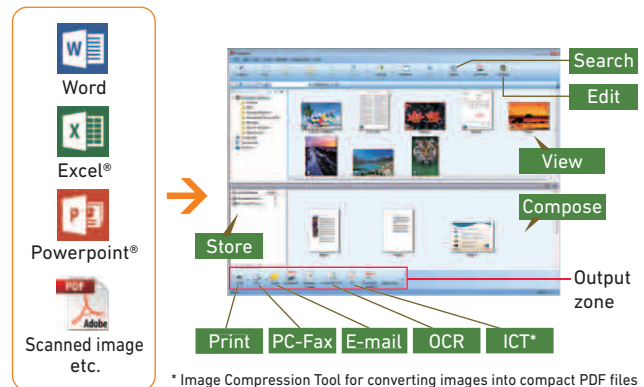

* Image Compression Tool for converting images into compact PDF files

Speedy Faxing

The MX-C300F/C250F also works as a 33.6 Kbps **Super G3 fax** machine capable of high-speed transmission. The RSPF and duplex module enable **duplex transmission*/reception**, allowing two-sided documents to be faxed in the proper order and incoming faxes to be printed on both sides of the paper.

* Available on MX-C300F

Versatile Fax Functions

- **PC-Fax** lets you send documents created on a PC directly to a recipient's fax machine via a phone line without printing to paper
- **Mixed size original scanning** automatically distinguishes documents of mixed sizes fed through the RSPF/SPF
- **Fax destination confirmation** allows users to reconfirm fax numbers before sending to prevent transmission errors
- **Inbound routing** lets you check incoming faxes via a network folder (SMB) before printing them out
- **Speed dial keys** register up to 300 numbers

OTHER OUTSTANDING FEATURES

Reliable Security

- **IPsec** (IP security) data encryption technology ensures secure network communications.
- User authentication covering up to 30 users prevents unauthorised MFP use by requiring access passwords.
- Retained data can be initialised when it's time to replace the MFP, preventing the leakage of confidential information.

Easy-To-Use Control Panel



SPECIFICATIONS (tentative)

General

Type	Desktop
Engine speed (colour & B/W)	Max. 30/25 cpm/ppm
Paper size	Max. A4 (8 1/2" x 14"), min. A6 (5 1/2" x 8 1/2")
Paper capacity (80 g/m ²)	Standard: 300 sheets (250-sheet tray and 50-sheet multi-bypass tray) Maximum: 800 sheets
Paper weight	Tray: 60 g/m ² to 105 g/m ² (16 lbs bond to 28 lbs bond) Multi-bypass tray: 55 g/m ² to 220 g/m ² (13 lbs bond to 80 lbs cover)
Warm-up time*1	29 sec.
Memory	Copy/print (shared): 512MB
Power requirements	Rated local AC voltage ±10%, 50/60 Hz
Power consumption (max.)	1.15 kW (220 to 240V), 1.1 kW (100 to 127V)
Dimensions (W x D x H)	MX-C300F: 429 x 509 x 421 mm (16 57/64" x 20 3/64" x 16 37/64") MX-C250F: 429 x 509 x 398 mm (16 57/64" x 20 3/64" x 15 43/64")
Weight (approx.)	MX-C300F: 29 kg (63.9 lbs) MX-C250F: 28 kg (61.8 lbs)

Copier

Original paper size	Max. A4 (8 1/2" x 14")
First copy time*2	Full colour: 18 sec. B/W: 10 sec.
Continuous copy	Max. 999 copies
Resolution	Scan*3: 600 x 600 dpi, 600 x 400 dpi, 600 x 300 dpi Print: 600 x 600 dpi
Gradation	Equivalent to 256 levels
Zoom range	25% to 400% (25% to 200% using RSPF/SPF) in 1% increments
Preset copy ratios	Metric: 8 ratios (4R/4E), inch: 5 ratios (3R/2E)

SYSTEM CONFIGURATION



COMPACT TONER CARTRIDGES



Network Printer

Resolution	600 x 600 dpi
Interface	USB 2.0, 10Base-T/100Base-TX
Supported OS	Windows Server® 2003, Windows Server® 2008, Windows Server® 2012, Windows® XP, Windows Vista®, Windows® 7, Windows® 8, Mac OS X10.4, X10.5, X10.6, X10.7, X10.8
Network protocols	TCP/IP (IPv4, IPv6)
Printing protocols	LPR, Raw TCP (port 9100), IPP, FTP for downloading print files
PDL (emulation)	PCL 6 emulation, PS3 emulation
Available fonts	80 fonts for PCL, 136 fonts for PS3 emulation

Network Scanner

Scan method	Push scan (via control panel) Pull scan (TWAIN-compliant application)
Resolution	Push scan: 100, 150, 200, 300, 400, 600 dpi Pull scan: 75, 100, 150, 200, 300, 400, 600 dpi 50 to 9,600 dpi via user setting*4
File formats	TIFF, PDF, JPEG*5
Scanner utility	Sharpdesk
Scan destinations	Scan to e-mail/desktop/FTP server/ network folder (SMB)/USB memory

Facsimile

Compression method	MH/MR/MMR/JBIG
Communication protocol	Super G3/G3
Transmission time	Less than 3 seconds*6
Modem speed	33,600 bps to 2,400 bps with automatic fallback
Transmission resolution	From Standard (203.2 x 97.8 dpi) to Super Fine (203.2 x 391 dpi)
Recording width	A4 to A5 (8 1/2" x 11" to 5 1/2" x 8 1/2")
Memory	8MB
Grey scale levels	Equivalent to 256 levels

- *1: At rated voltage, 23°C (73.4°F). May vary depending on operating conditions and environment.
- *2: Short-edge feeding of A4 (8 1/2" x 11") sheets from 1st paper tray, using document glass, MFP in fully ready condition. May vary depending on operating conditions and environment.
- *3: Default resolution when using document glass is 600 x 400 dpi and is 600 x 300 dpi when using RSPF/SPF.
- *4: Resolutions higher than 600 dpi are interpolated.
- *5: Colour only.
- *6: Based on Sharp's standard chart with approx. 700 characters (A4 or 8 1/2" x 11" long-edge feeding) at standard resolution in Super G3 mode, 33,600 bps, JBIG compression.

- Design and specifications are subject to change without prior notice.
- Windows, Windows Server, and Windows Vista are registered trademarks of Microsoft Corporation in the US and/or other countries. All other brand names and product names may be trademarks or registered trademarks of their respective owners.
- The ENERGY STAR logo is a certification mark and may only be used to certify products that have been determined to meet the ENERGY STAR programme requirements. ENERGY STAR is a US registered mark. The ENERGY STAR guidelines apply to products only in the US, the EU, Japan, Canada, Australia, New Zealand, and Taiwan.

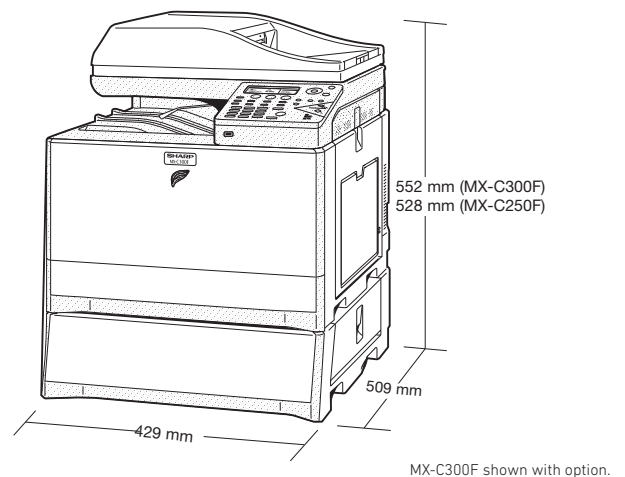

Distributed by: